

I PROJECTION OF STRAIGHT LINES

What is Line?

A Shortest distance between two points and the actual length of the line is known as True Length denoted by TL.

Orientation of Straight Lines

- Line parallel to both H.P and V.P
- Line perpendicular to H.P and parallel to V.P
- Line perpendicular to V.P and parallel to H.P
- Line inclined to H.P and parallel to V.P
- Line inclined to V.P and parallel to H.P
- Line situated in H.P
- Line situated in V.P
- Line situated in both H.P and V.P
- Line inclined to both the reference planes.

1. Line inclined to both H.P and V.P front view angle and top view angle = 90 deg

2. Line inclined to both H.P and V.P front view angle and top view angle = 90 deg

Problems

- Line parallel to both H.P and V.P**

A 50mm long line AB is parallel to both H.P and V.P. The line is 25mm in front of V.P and 60mm above H.P, draw the projections of the line.

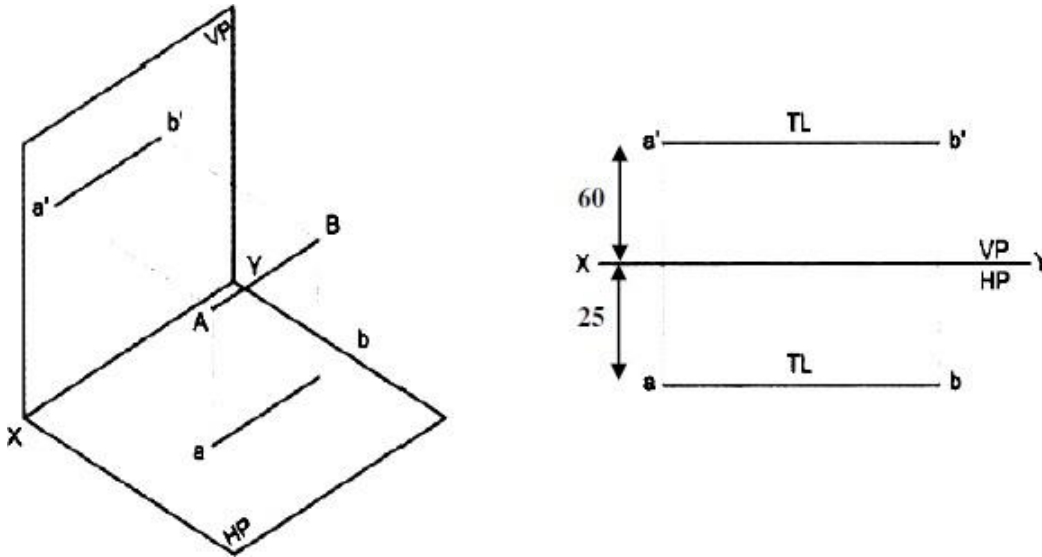

Line perpendicular to H.P

A 60mm long line AB has its end A at a distance of 20mm above the H.P. The line is perpendicular to the H.P and 40mm in front of V.P, draw the projections of the line.

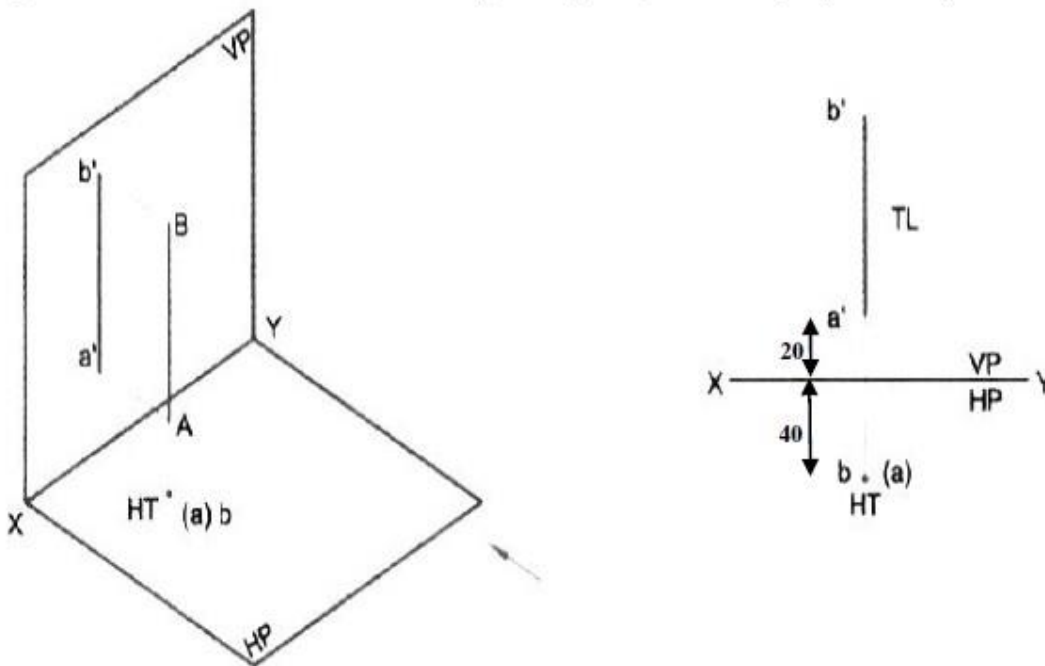

Line perpendicular to V.P

A 60mm long line AB, has its end A at a distance of 20mm in front of the V.P. the line is

perpendicular to V.P and 40mm above H.P, draw the projection of the line.

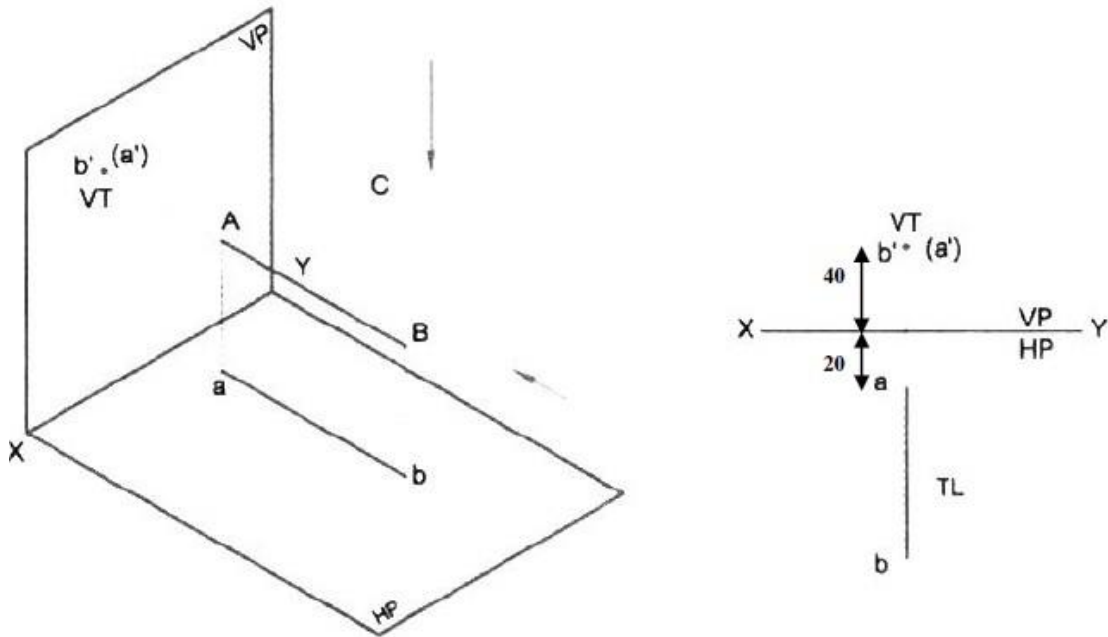

Line inclined to H.P and parallel to V.P

A 80mm long line AB has the end A at a distance of 20mm above HP and 40mm in front of V.P. The line is inclined at 30 deg to H.P and parallel to V.P, draw the projection of the line.

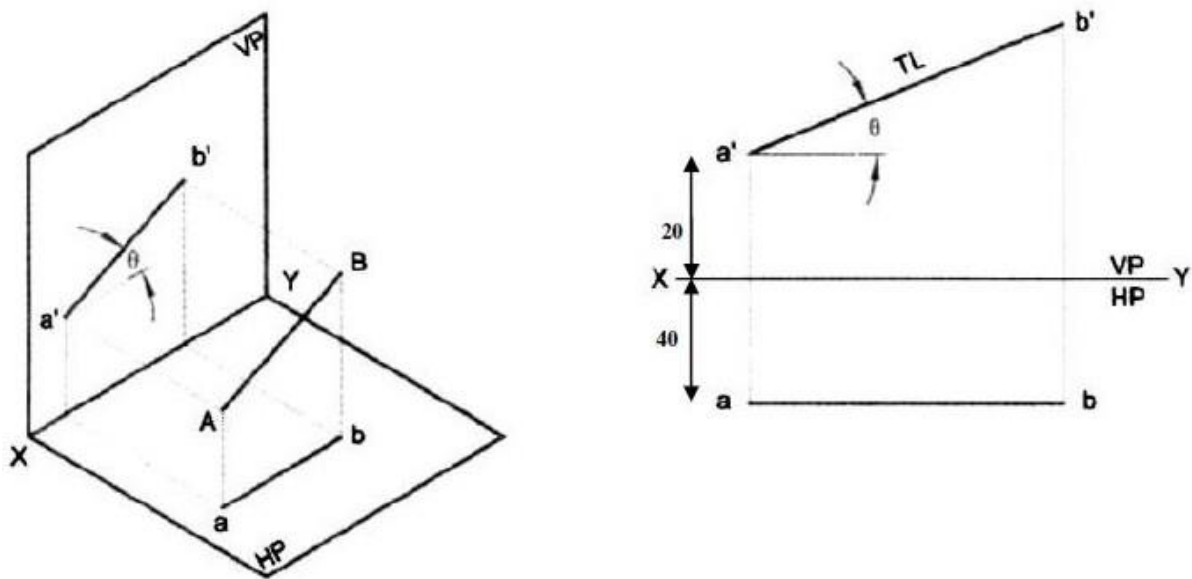

Line inclined to V.P and parallel to H.P

An 80mm long line AB is inclined at 30 deg to V.P and is parallel to H.P. The end A is 20mm above the H.P and 20mm in front of the V.P, draw the projection of the line.

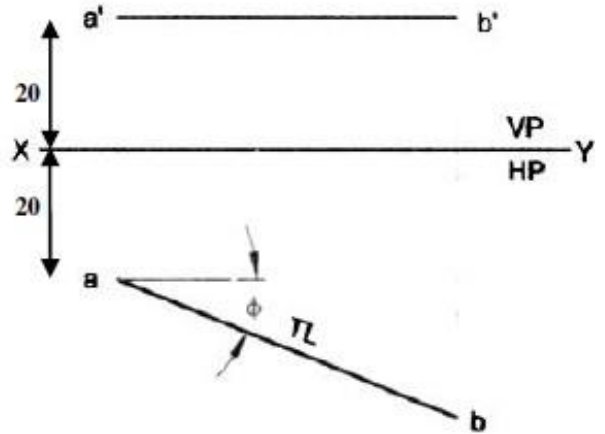
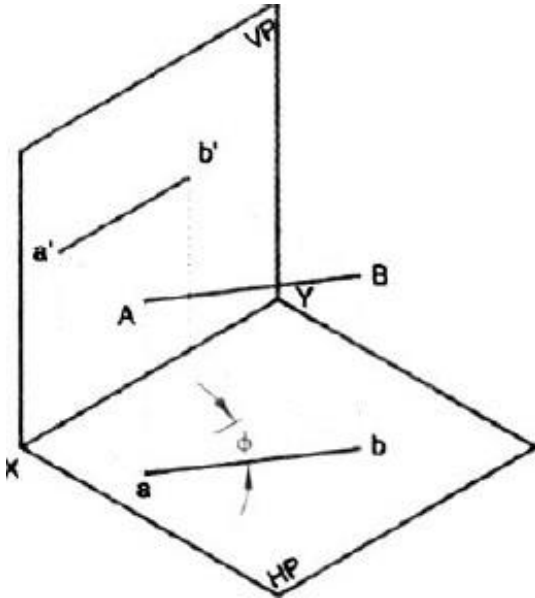

Line situated in H.P

A line AB 60mm long is situated in H.P and inclined to V.P at 30 deg. The end A is 20mm in front of V.P, draw the projection of line.

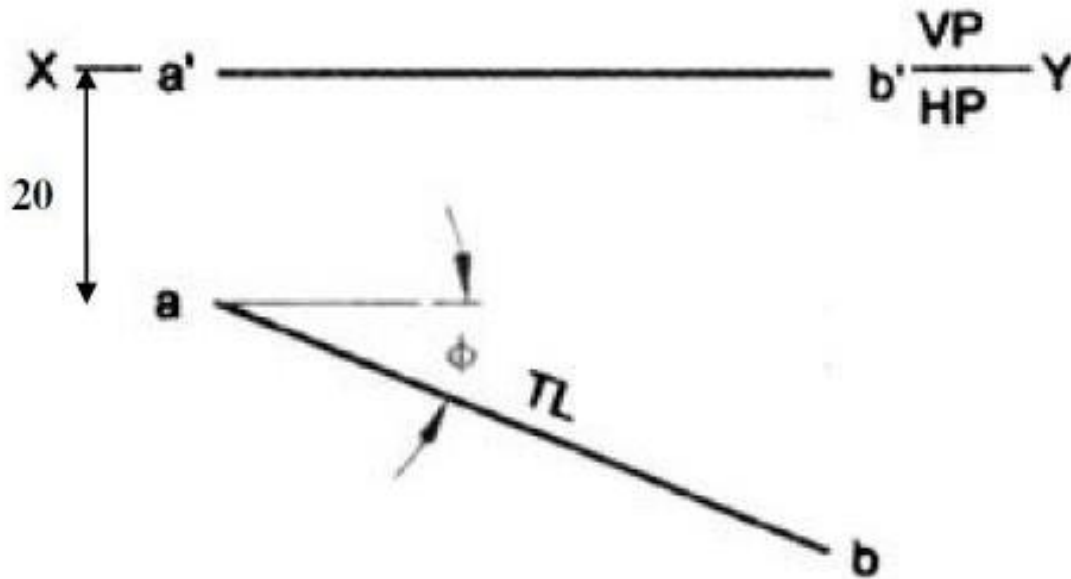

□ **Line situated in V.P**

Draw the projections of 70mm long line AB situated in the V.P and inclined at 30 deg to H.P. The end A is 25 mm above H.P.

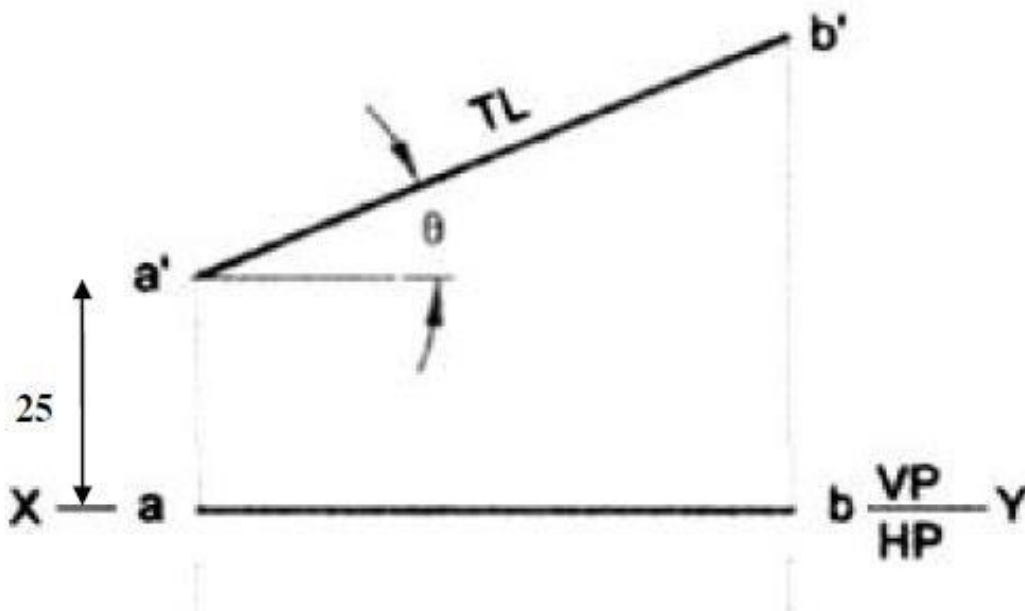

Lines inclined to both the reference planes.

A 70mm long line AB has an end A at 20mm above H.P and 30mm in front of V.P. The line is inclined at 45 deg to the H.P and 30 deg to V.P, draw the projections.

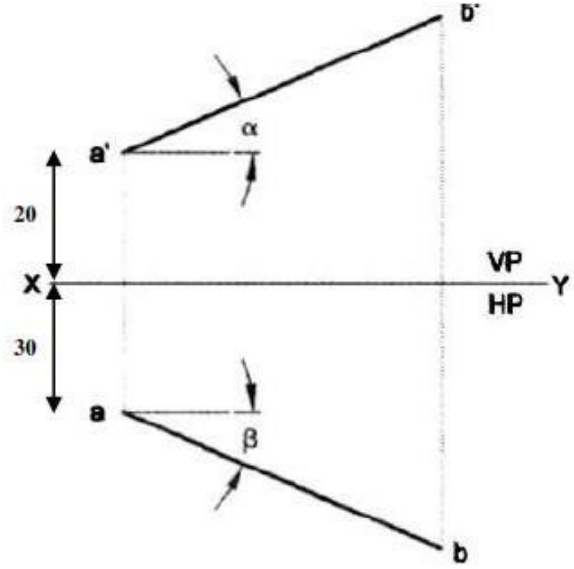
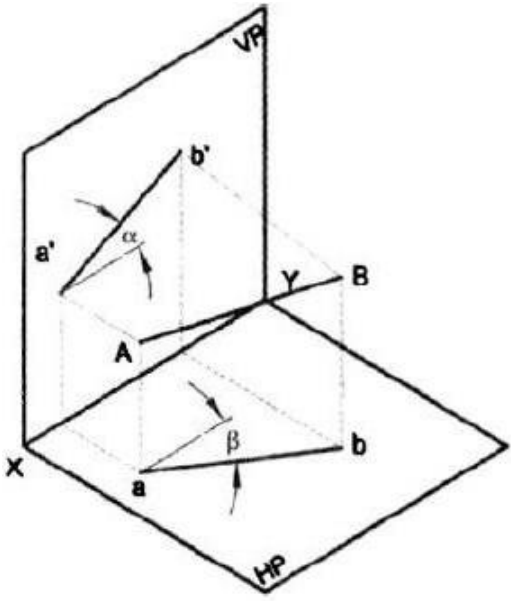

Problem:

A line AB, 70mm long, has its end A 15mm above HP and 20mm in front of VP. It is inclined at 30° to HP and 45° to VP. Draw its projections and mark its traces

